

Cascade Control

What We Will Learn in This Section

- The Cascade Control Architecture
- Benefits of a Cascade Strategy
- Design and Tuning a Cascade Controller
- Application to a Flash Drum Process
- Application to a Jacketed Reactor

Cascade Control

- Architectures for improved disturbance rejection
 - Feed Forward
 - Cascade
- Both require additional instrumentation and engineering time in return for a controller better able to reject disturbances
- Neither architecture benefits nor detracts from set point tracking performance

Traditional Feedback Loop is in the Dashed Circle

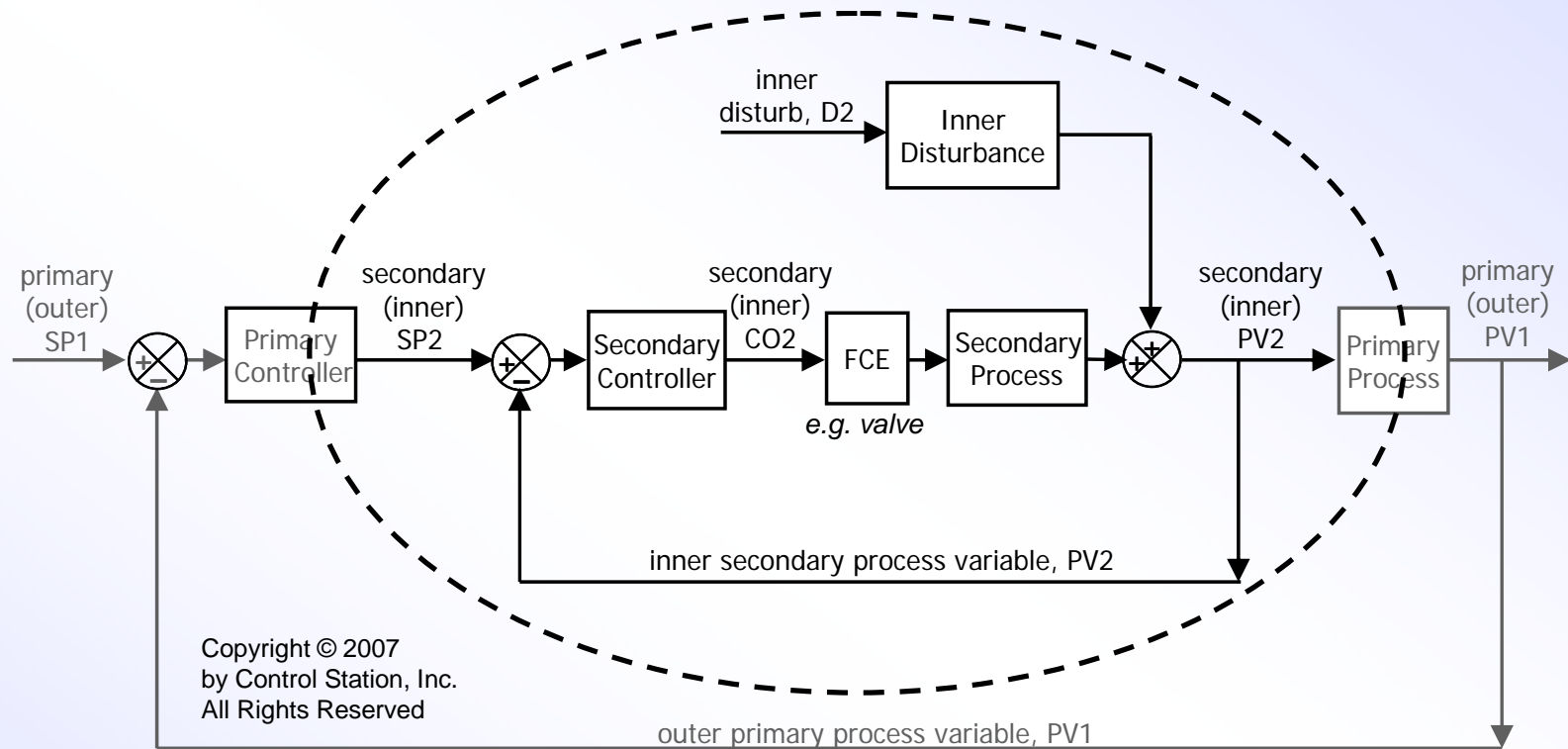

- A cascade is comprised of two ordinary PID controllers
- The inner secondary loop has a traditional feedback structure, and it is nested inside the outer primary loop

Nested Loops Work to Protect Outer Primary PV1

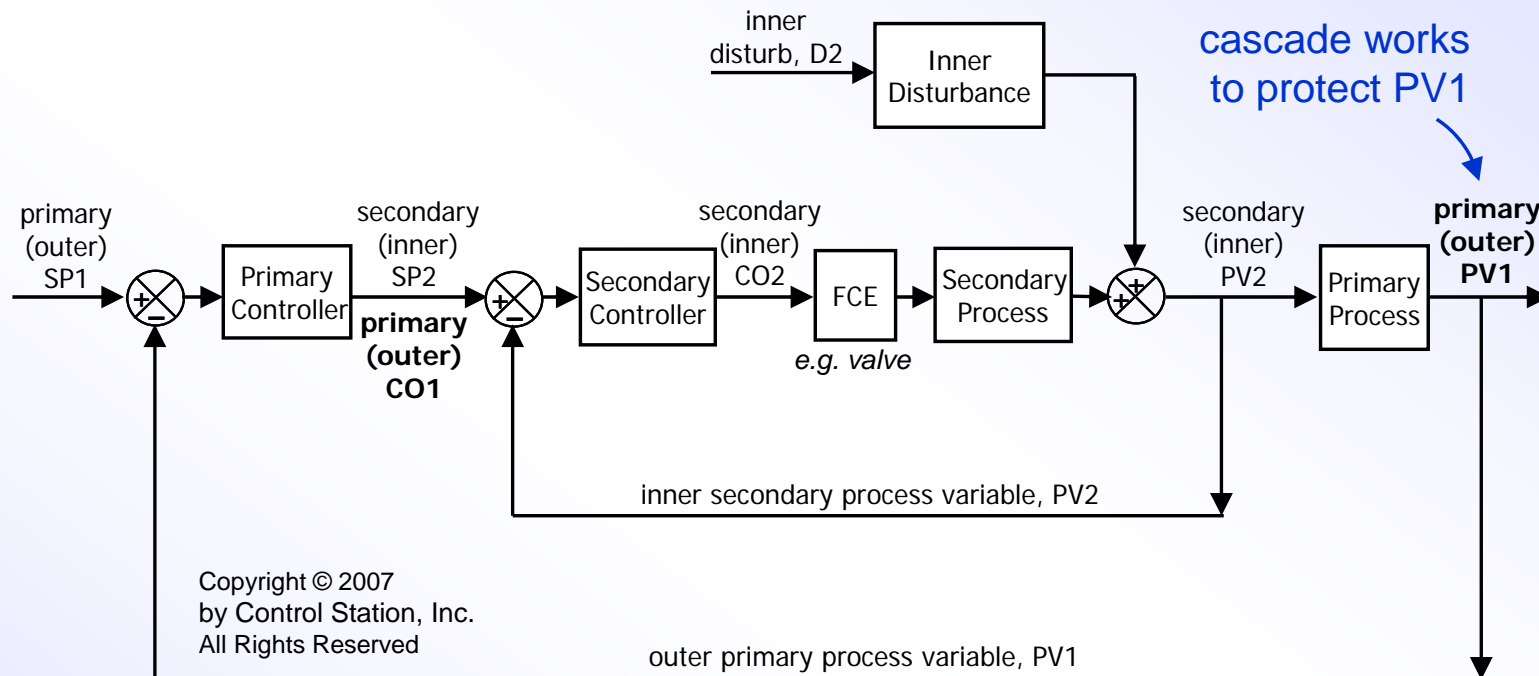

- Cascade architectures seek to improve the disturbance rejection performance of PV1

Early Warning is Basis for Cascade Success

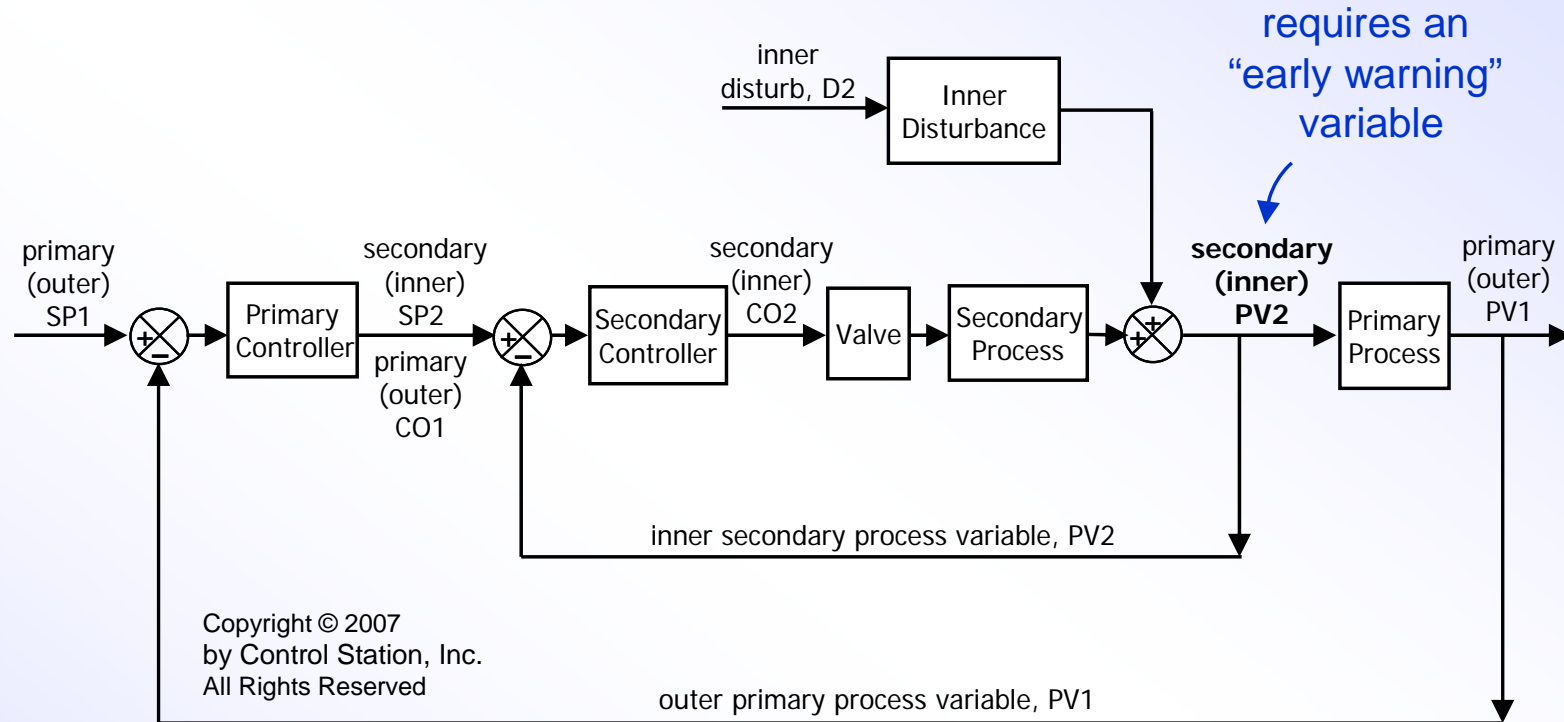

- Success in a cascade design depends on the measurement and control of an "early warning" process variable PV2

Cascade Design

- Characteristics for selecting early warning PV2 include:
 - it must be measurable with a sensor
 - the same FCE (e.g., valve) used to manipulate PV1 also manipulates PV2
 - the same disturbances that are of concern for PV1 also disrupt PV2
 - PV2 responds before PV1 to disturbances of concern and to FCE manipulations

Cascade Design

- A cascade design requires:
 - two sensors
 - two controllers
 - one final control element (FCE)
- The output of the outer primary controller, rather than going to a valve, becomes the set point of the inner secondary controller
- Because of this nested architecture:

*Success requires that
the settling time of the inner secondary inner loop
is significantly faster
than that of the outer primary outer loop*

Example: Flash Drum Process

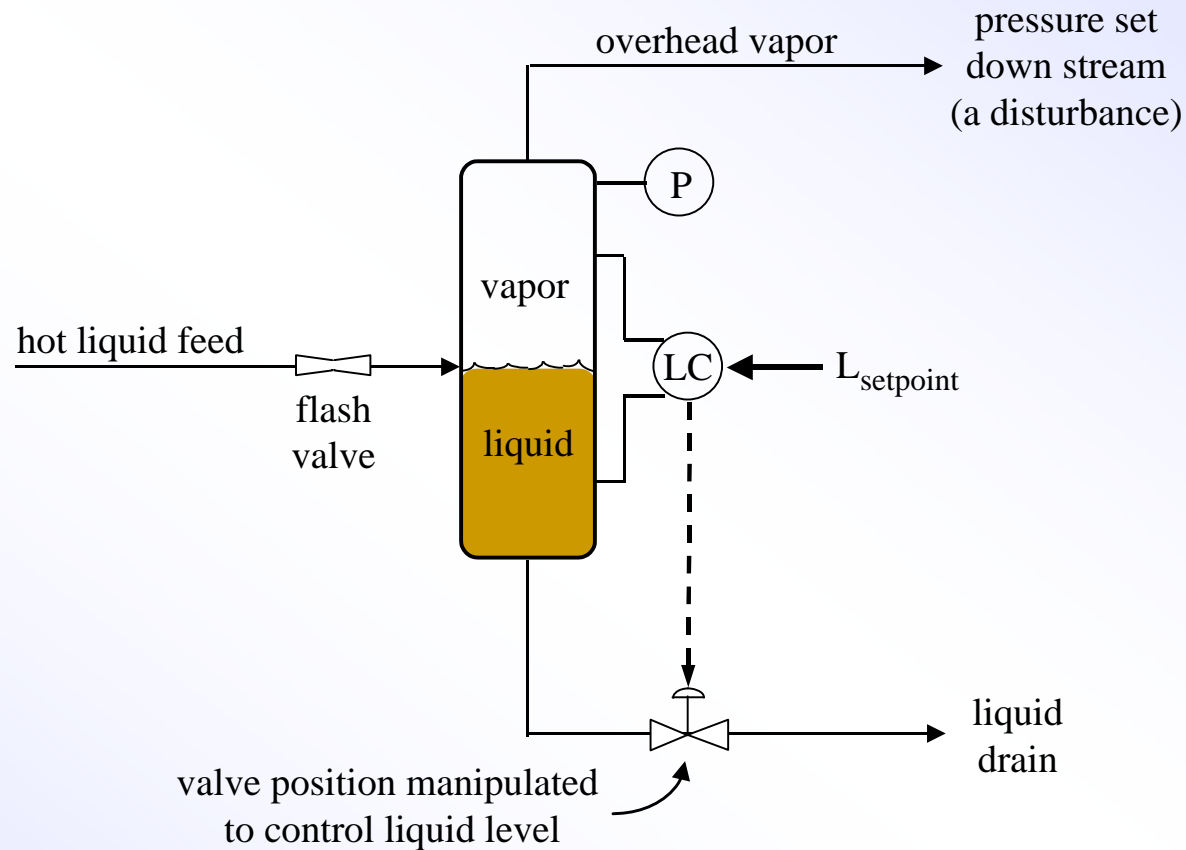

- Level must never fall so low that vapor is sent down liquid drain nor rise so high that liquid enters the vapor line

Flash Drum – Single Loop Architecture

- Design Objective → control liquid level in the drum
- Choose valve position as manipulated variable
 - If level too high, open valve
 - If level too low, close valve
- Concern is that drain flow rate changes as a function of
 - valve position
 - hydrostatic head (height of the liquid)
 - pressure of vapor pushing down on liquid (a disturbance)

Flash Drum

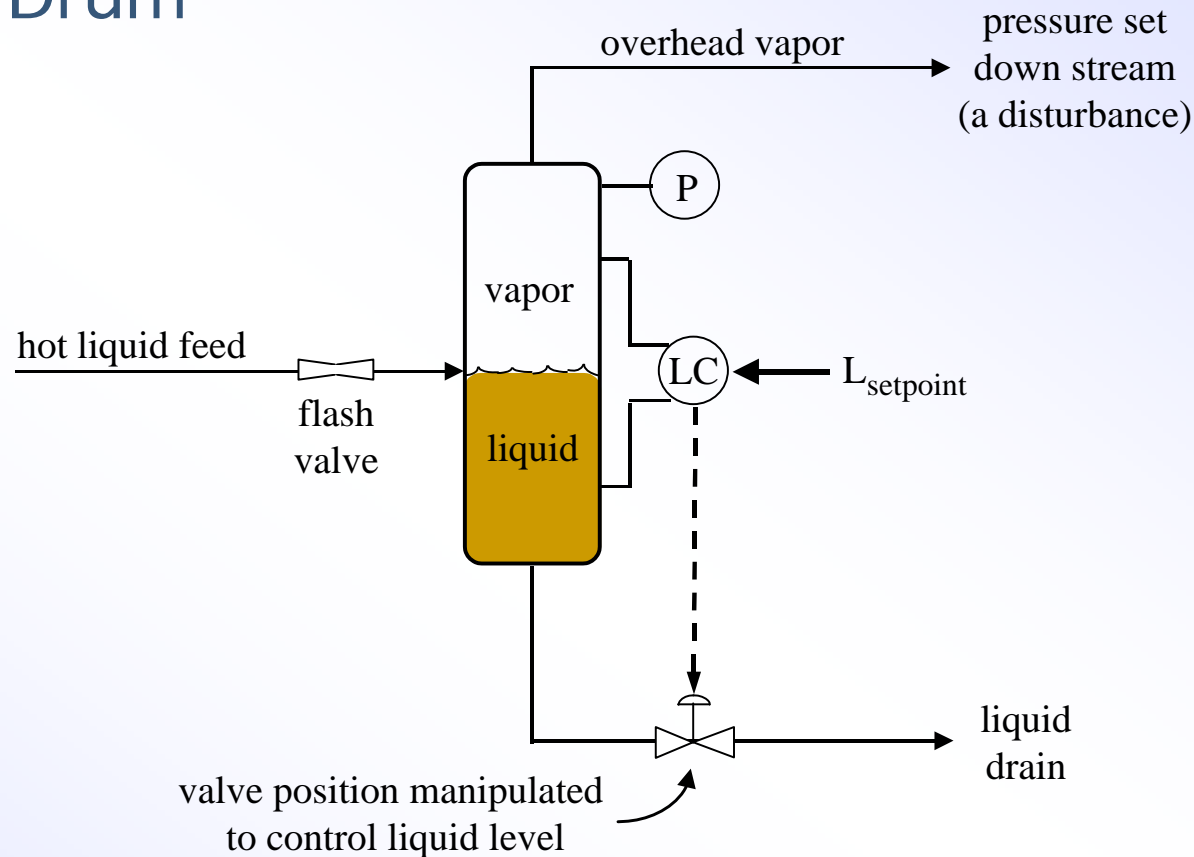

- If pressure of vapor phase is constant, then as drain valve opens and closes, the liquid drain flow rate increases and decreases in predictable fashion
- Single loop architecture would then be satisfactory

Flash Drum – Single Loop Architecture

- Suppose the vapor phase pressure starts decreasing:
 - This disturbance causes pressure pushing down on the liquid interface to decrease
 - If the valve position were to remain constant, the liquid drain flow rate would similarly decrease
 - Consider that if a pressure decrease occurs quickly enough, the controller can be opening the valve yet the liquid drain flow rate can continue to decrease

This contradictory outcome can confound the controller

- Observation → It is liquid drain flow rate, not valve position, that must be adjusted for high performance disturbance rejection

Solution: Flash Drum Cascade Architecture

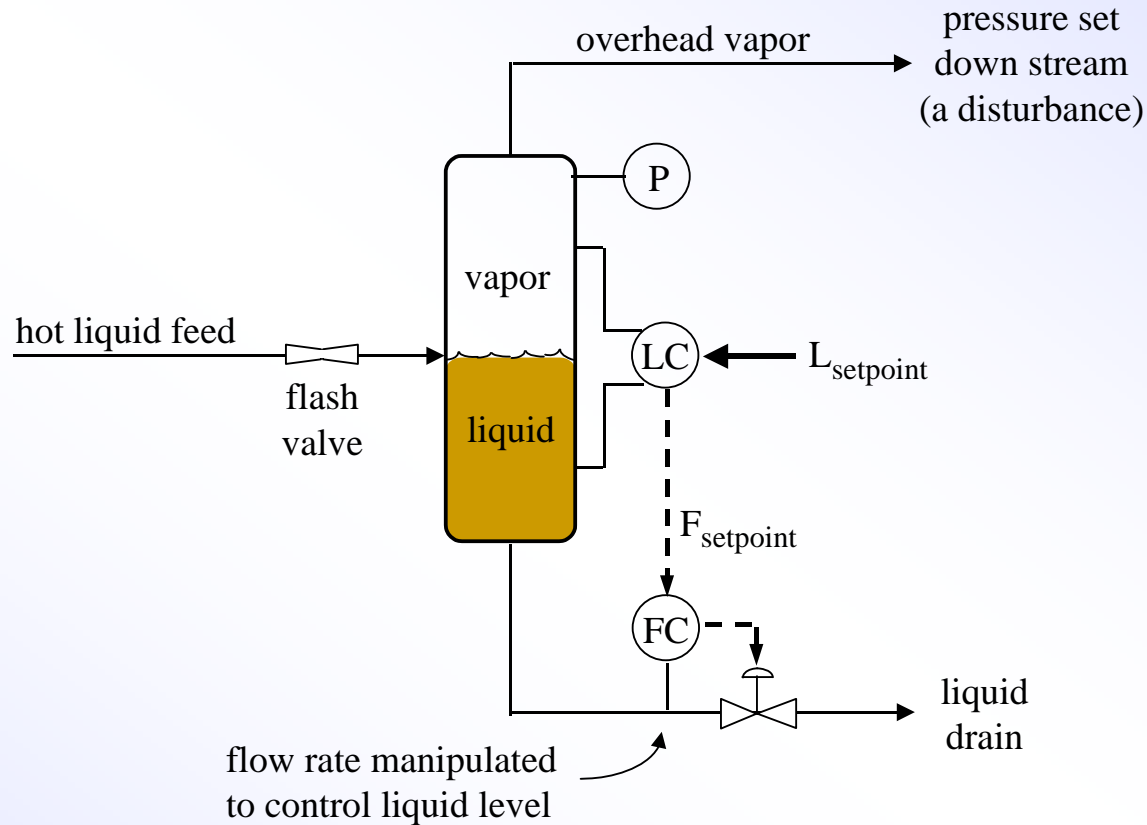

- Two controllers (level control; drain flow rate control)
- Two sensors (measuring liquid level; liquid drain flow rate)
- One final control element (valve in the liquid drain stream)

A Cascade Control Solution

- Liquid level is the outer primary PV1 and controlling it remains the main objective
- For inner secondary PV2 choose liquid drain flow rate:
 - liquid drain flow rate is measurable with a sensor
 - the same valve used to manipulate liquid level (PV1) also manipulates the liquid drain flow rate (PV2)
 - changes in vapor phase pressure that disturb PV1 also impact PV2
 - drain flow rate is *inside* the liquid level in that it responds well before liquid level to changes in valve position and changes in vapor phase pressure

Flash Drum Cascade Architecture

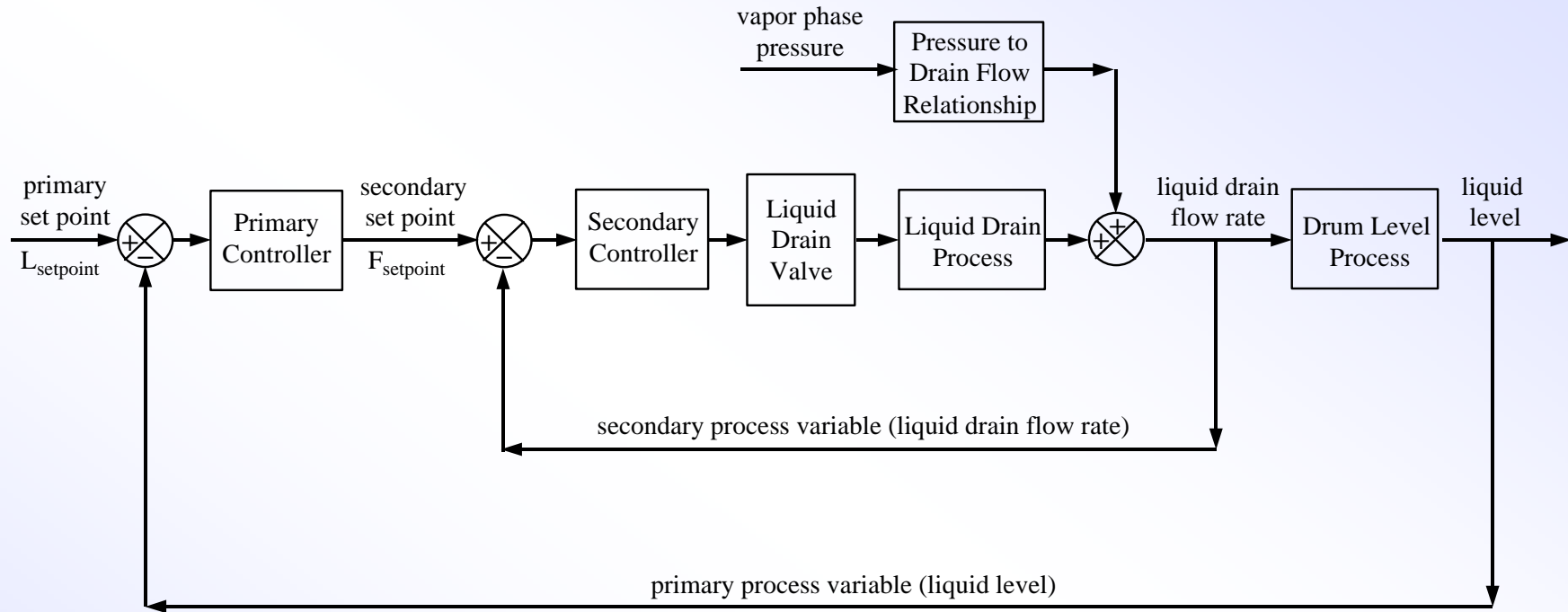

- Liquid level control (main objective) is outer primary loop
- Liquid drain flow rate is inner secondary loop
- Output of primary controller is set point of secondary controller
- Flow control dynamics are much faster than level control dynamics so this is consistent with design criteria

Flash Drum Cascade Architecture

- If liquid level is too high, the primary level controller now calls for an increased liquid drain flow rate rather than simply an increase in valve opening
- The flow controller then decides whether this means opening or closing the valve and by how much
- Thus, a vapor phase pressure disturbance gets addressed quickly by the secondary flow controller and this improves disturbance rejection performance

Tuning a Cascade Implementation

- Cascade loop tuning uses our existing skills:
 - Begin with both controllers in manual mode
 - Select P-Only controller for the inner secondary loop (integral action increases settling time and offset is rarely an issue for the secondary process variable)
 - Tune the secondary P-Only controller for set point tracking and test it to ensure satisfactory performance
 - Leave secondary controller in automatic; it is now part of the primary process. Select a PI or PID controller for the primary loop, tune it for disturbance rejection and test it
 - With both controllers in automatic, tuning is complete

Exploring the Jacketed Reactor Process

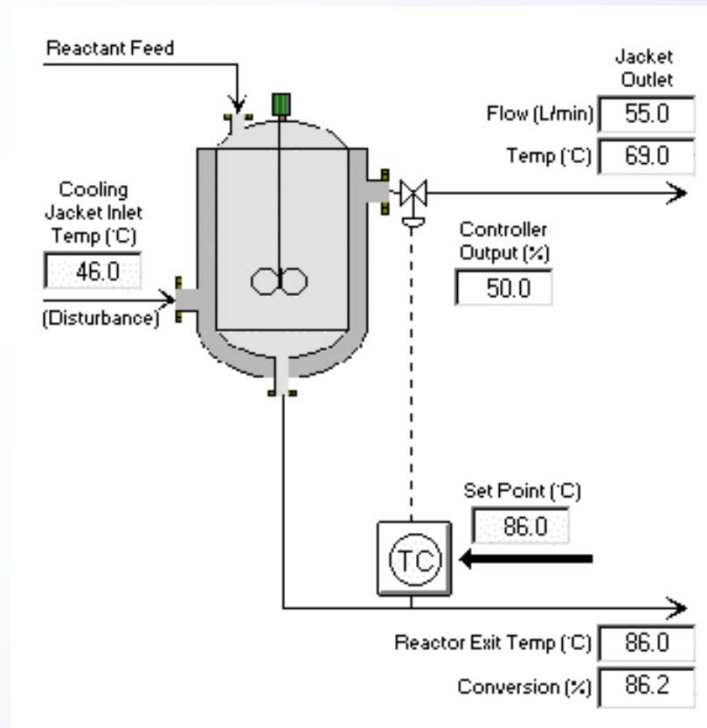

- Well mixed vessel with exothermic (heat producing) reaction
- Residence time is constant so conversion of feed to product can be inferred from the reactor exit stream temperature
- Objective → maintain constant measured reactor exit stream temperature in spite of jacket inlet temperature disturbances

The Jacketed Reactor

- To control reactor exit stream temperature, the vessel is enclosed with a cooling jacket
- If the exit stream temperature (and thus conversion) is high, the controller opens a valve to increase cooling liquid flow rate
- This cools the reactor, slowing the heat producing reaction
- The disturbance variable of concern is the cooling jacket inlet temperature

Disturbances and the Jacketed Reactor

- Consider scenario where the temperature of the cooling liquid entering the jacket fluctuates, changing the ability of the cooling jacket to remove heat
- If the cooling liquid temperature becomes colder just as the reactor temperature starts to fall, the controller can lower the cooling liquid flow rate yet be removing more heat than before
- Again, a **contradictory result** can confound the controller and impact disturbance rejection performance

Cascade Architecture for the Jacketed Reactor

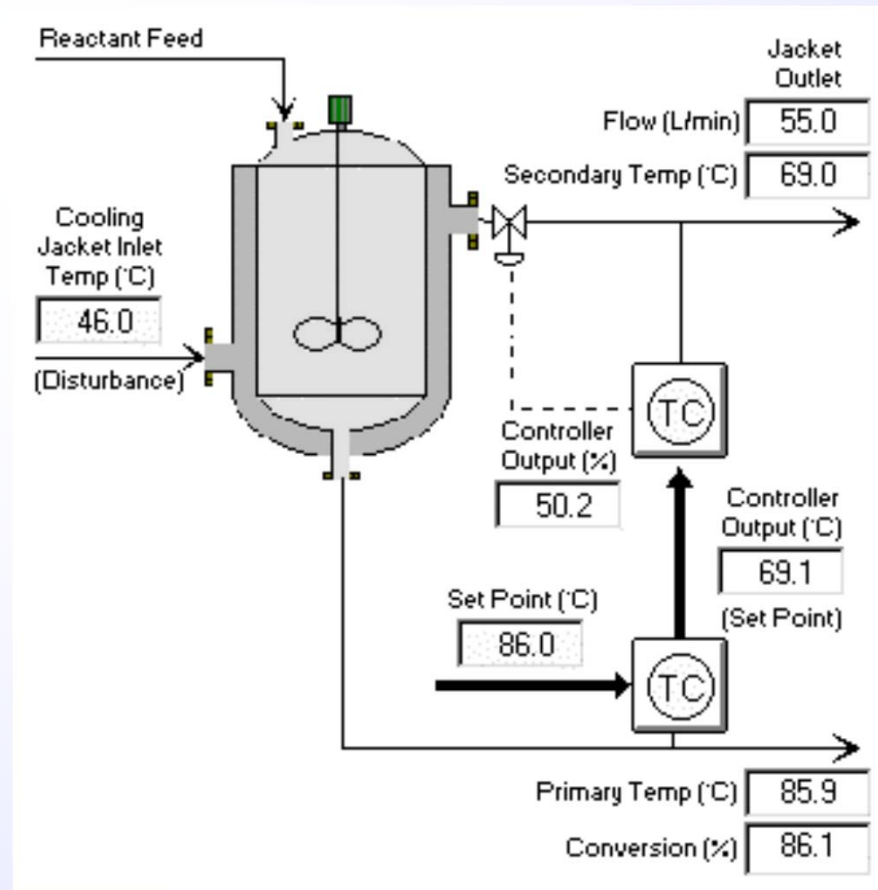

- Outer primary variable remains reactor exit stream temperature
- Inner secondary variable is cooling jacket outlet temperature

The Reactor Cascade Architecture

- Cooling jacket outlet temp is a proper secondary variable
 - it is measurable with a sensor
 - valve used to manipulate reactor exit stream temperature (PV1) also manipulates cooling jacket outlet temp (PV2)
 - changes in cooling jacket inlet temperature that disturb reactor exit stream temp also disturb the cooling jacket outlet temp
 - the cooling jacket outlet temp is *inside* the reactor exit temp in that it responds first to changes in valve position and changes in the cooling jacket inlet temperature

The Reactor Cascade Architecture

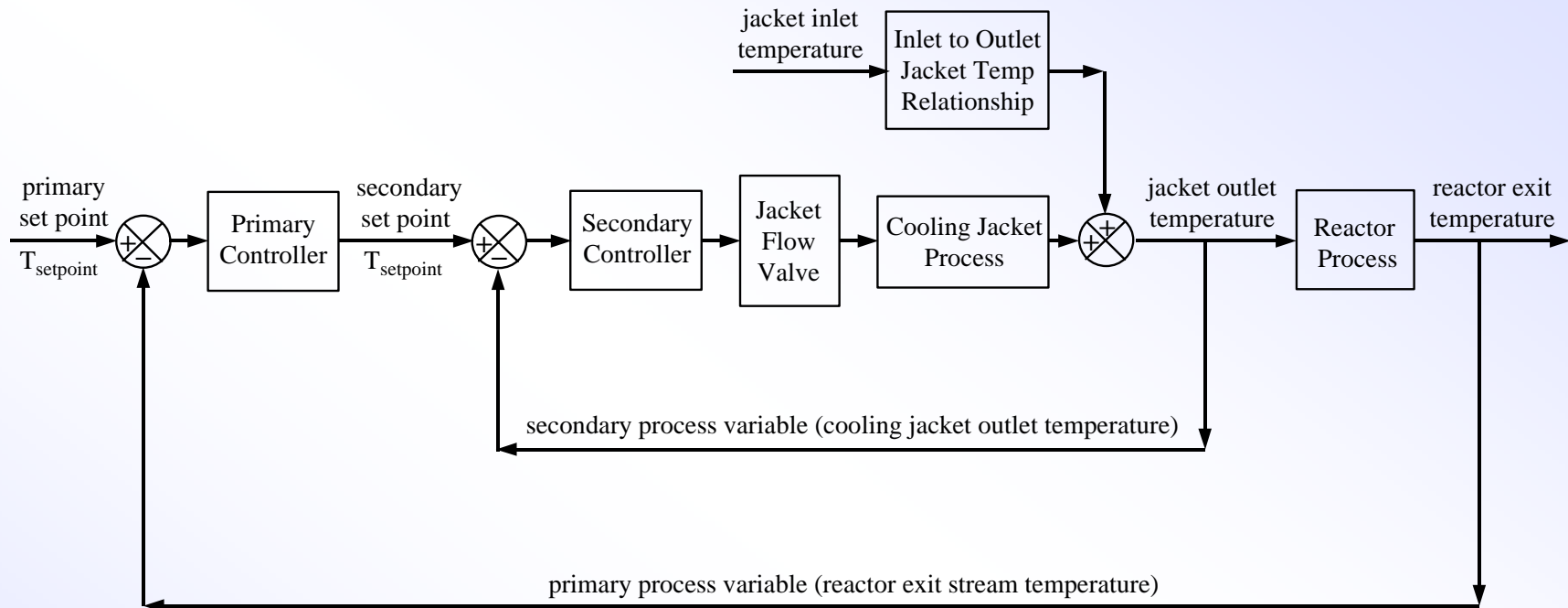

- Outer primary process (PV1) is reactor exit temperature
 - measured variable is reactor exit stream temperature
 - controller output is set point of secondary controller
- Inner secondary process (PV2) is the cooling jacket
 - measured variable is the cooling jacket outlet temperature
 - manipulated variable is the cooling jacket liquid flow rate

Disturbance Rejection Comparison

Disturbance Rejection Performance of Single Loop PI Controller

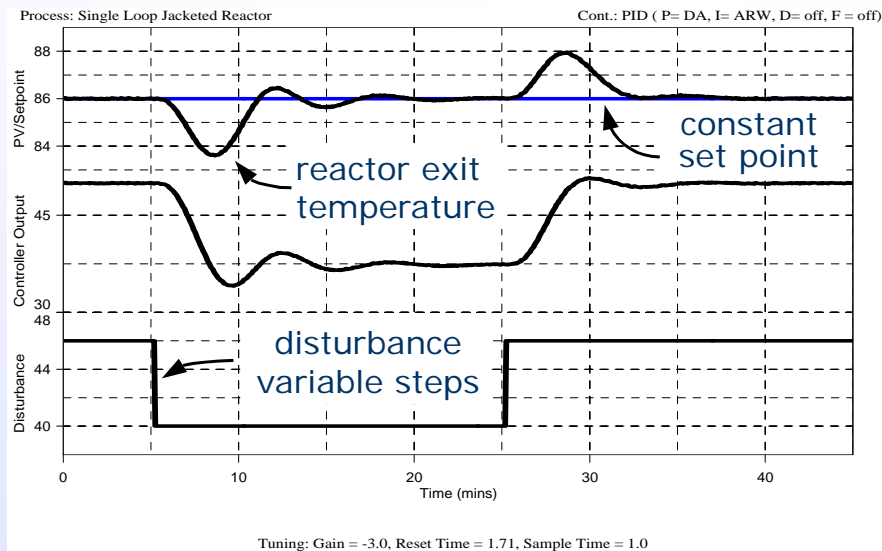

Disturbance Rejection Performance of Cascade Architecture

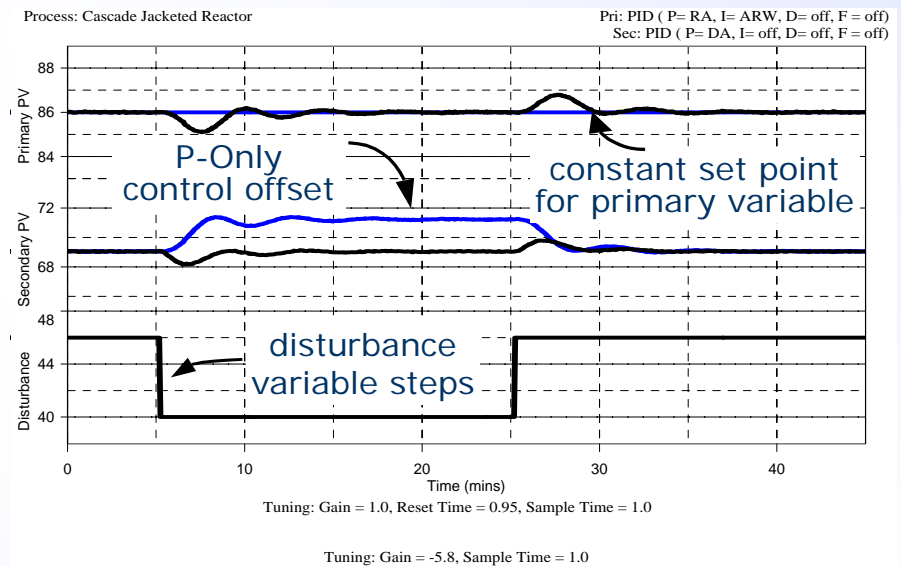

Set Point Tracking Comparison

Set Point Tracking Performance Under PI Control

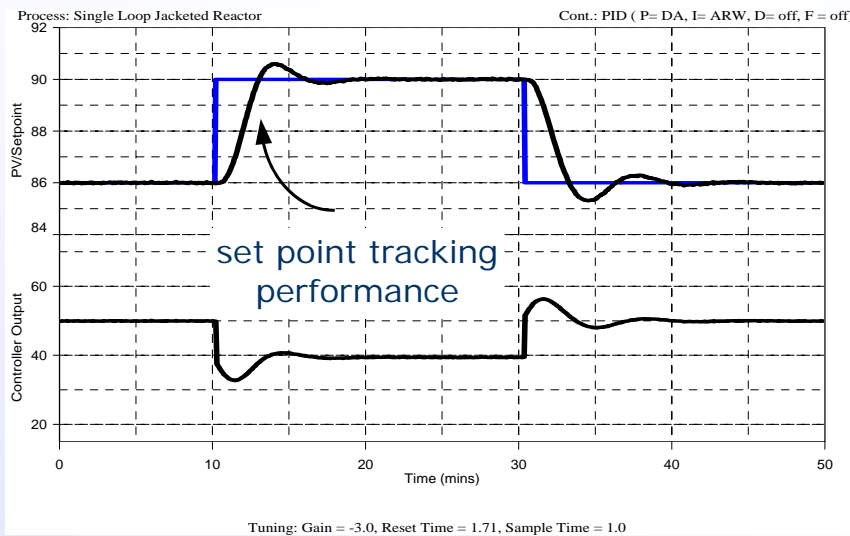

Set Point Tracking Performance Under Cascade Control

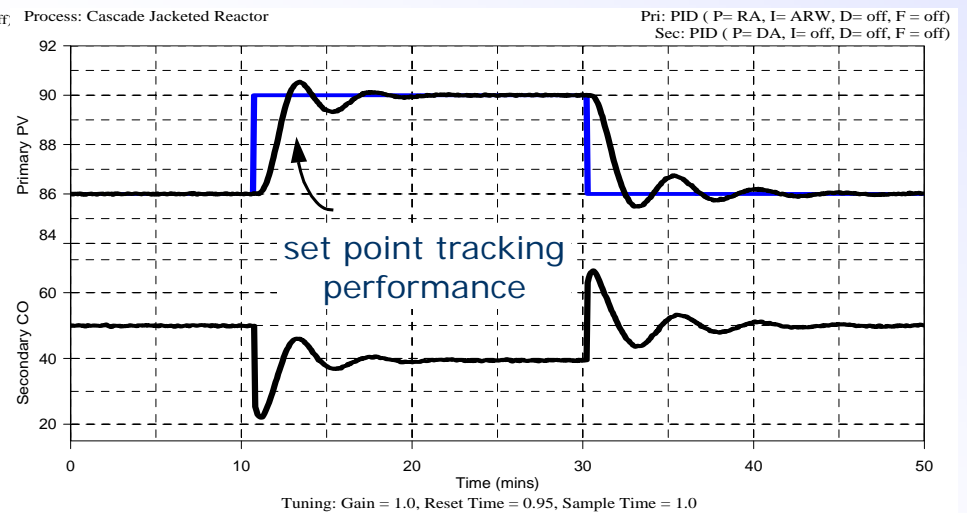

- Cascade does not provide benefit in tracking set point changes